

# 7847801COM Nightstand

**NOV  
OGR  
ATZ**

Date of Purchase \_\_\_ / \_\_\_ / \_\_\_  
Lot Number:

B347847801COM00KX

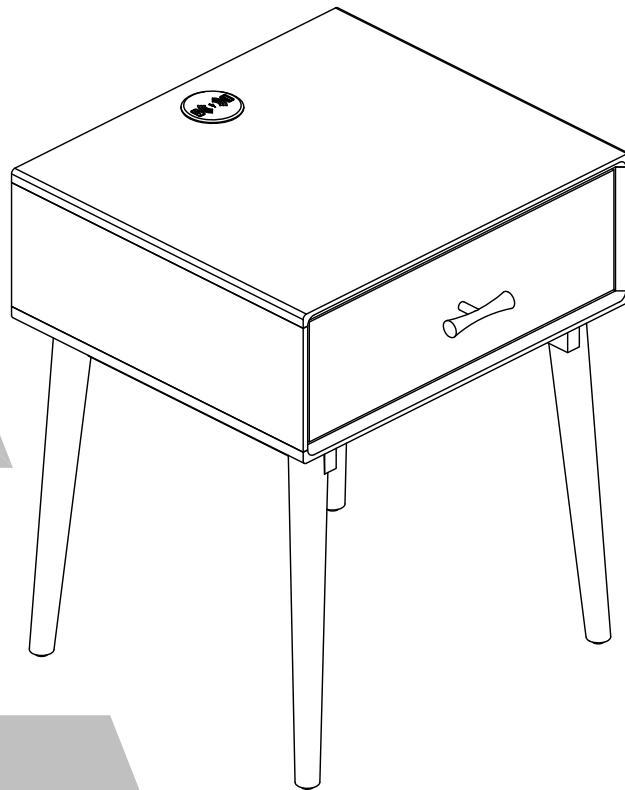

THIS INSTRUCTION BOOKLET CONTAINS **IMPORTANT** SAFETY INFORMATION. PLEASE READ AND KEEP FOR FUTURE REFERENCE.

### Do Not Return This Product!

Contact our customer service team for help first.

**Call:** 1-800-489-3351 (toll free)

Monday-Friday 9am - 5pm CST

**Visit:** [www.ameriwoodhome.com](http://www.ameriwoodhome.com)

## WARNING

- Unit can tip over causing severe injury or death.
- Anchor unit to stud in wall (if instructed to).
- Do Not allow children to climb on unit.
- Put heavy items on lower shelves or drawers.

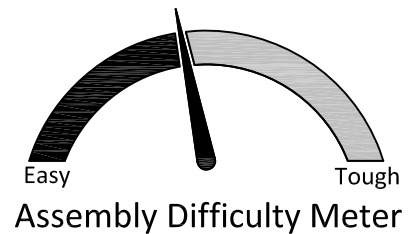

Follow Ameriwood Home



# Contact Us!

## Do NOT return this product!

Contact our friendly customer service team first for help.

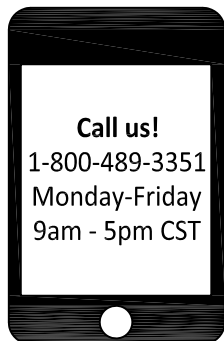

Visit [ameriwoodhome.com](http://ameriwoodhome.com)

Assembly Tips



# Helpful Hints

PEOPLE NEEDED FOR ASSEMBLY: **1-2**

ESTIMATED ASSEMBLY TIME: **1 HOUR**

- Open your item in the area you plan to keep it to avoid excessive heavy lifting.
- Identify, sort and count the parts before attempting assembly.
- Compression dowels are lightly tapped in with a hammer.
- Slides are labeled with a **R** (right) and **L** (left) for proper placement.
- Make sure to always face the point on the top of the Cam Lock towards the outer edge.
- Use all the nails provided for the back panel and spread them out equally.
- Back panel must be used to make sure your unit is sturdy.
- Do NOT use harsh chemicals or abrasive cleaners on this item.
- Never push, pull, or drag your furniture.

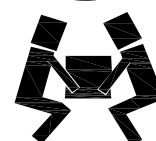

# Before You Start

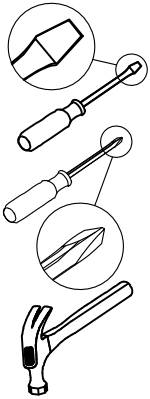
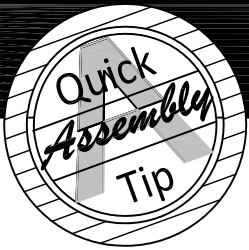

- ✓ Read through each step carefully and follow the proper order
- ✓ Separate and count all your parts and hardware
- ✓ Give yourself enough room for the assembly process
- ✓ Have the following tools: Flat Head Screwdriver, #2 Phillips Head Screwdriver and Hammer
- ✓ Caution: If using a power drill or power screwdriver for screwing, please be aware to slow down and stop when screw is tight. Failure to do so may result in stripping the screw.

# Cam Lock Fastening System

This Cam Lock Fastening System will be used throughout the assembly process.

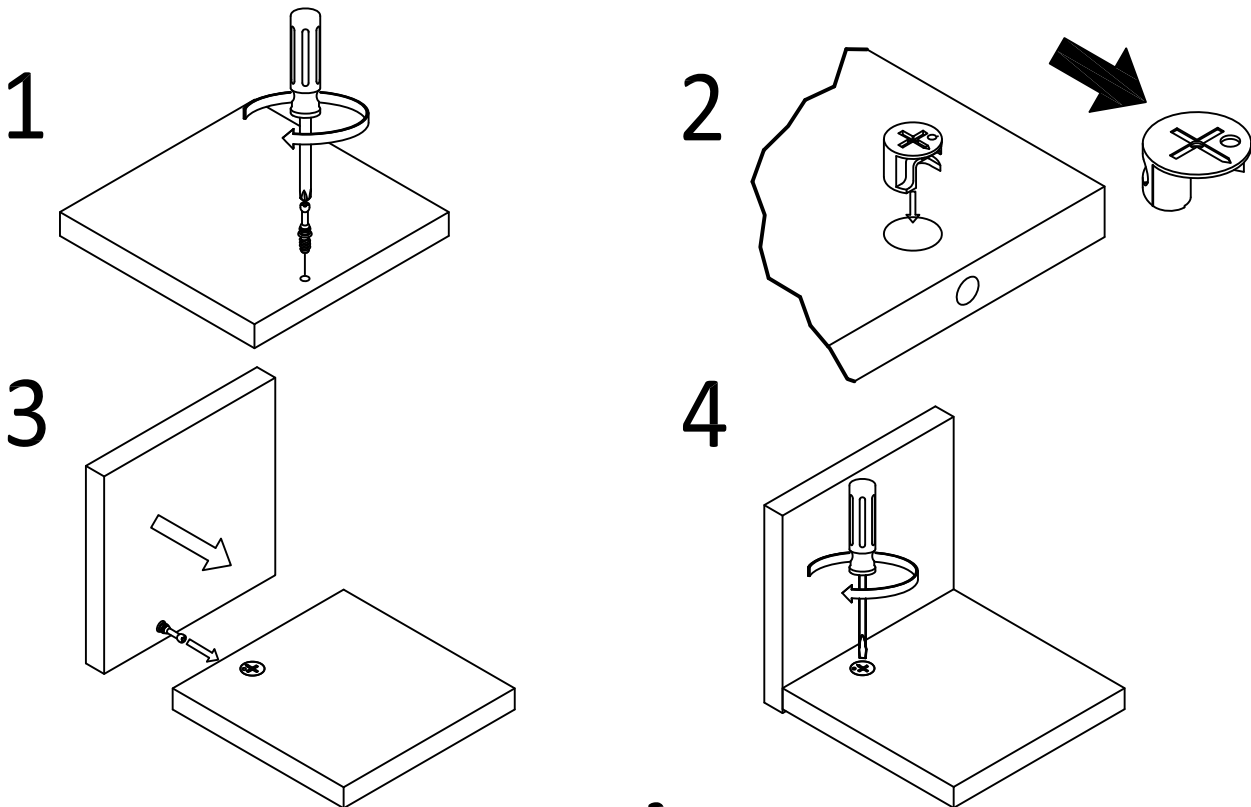

# Board Identification

Not Actual Size

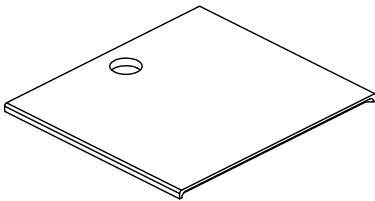

**(A)**

Top panel  
T7847801010KX

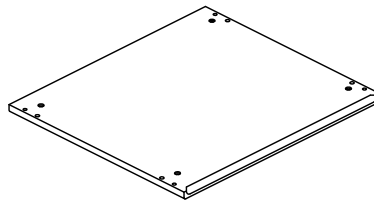

**(B)**

Bottom panel  
T7847801020KX

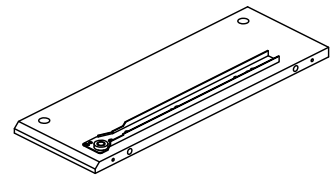

**(C)**

Left side panel  
T7847801030KX

Preassembled parts	
Left side panel	T7847801031KX
Left slide track	TKX1027-2
Screw Ø3*12 (3)	TKX1016

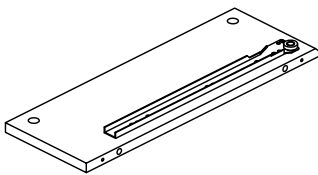

**(D)**

Right side panel  
T7847801040KX

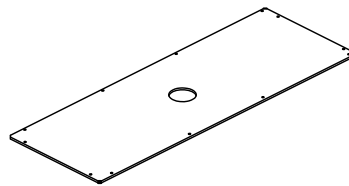

**(E)**

Back panel  
T7847801050KX

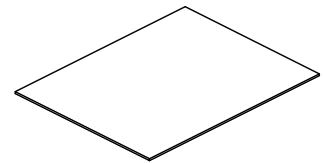

**(F)**

Drawer bottom  
T7847801060KX

Preassembled parts	
Right side panel	T7847801041KX
Right slide track	TKX1028-2
Screw Ø3*12 (3)	TKX1016

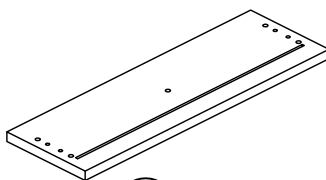

**(G)**

Drawer front  
T7847801070KX

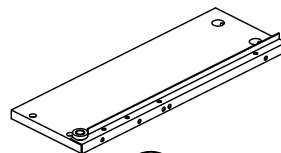

**(H)**

Left drawer side  
T7847801080KX

Preassembled parts	
Left drawer side	T7847801081KX
Left slide track	TKX1027-1
Screw Ø3*12 (3)	TKX1016

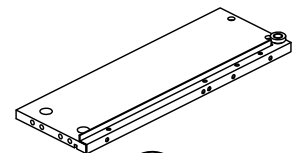

**(I)**

Right drawer side  
T7847801090KX

Preassembled parts	
Right drawer side	T7847801091KX
Right slide track	TKX1028-1
Screw Ø3*12 (3)	TKX1016

# Board Identification

Not Actual Size

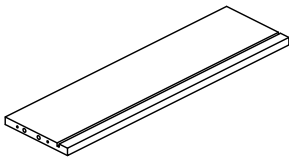

**J**

Drawer back  
T7847801100KX

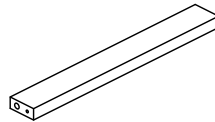

**K**

Bottom support  
T7847801110KX

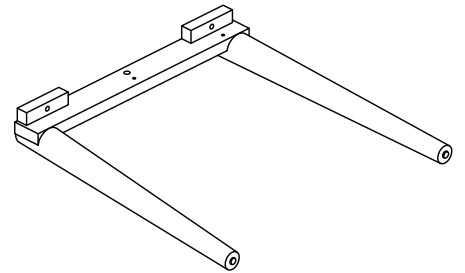

**L**

Leg frame  
T7847801120KX  
QTY:2PCS

Preassembled parts	
Leg frame (2)	T7847801121KX
Tack glide Ø15 (4)	TKX1179

# Board Identification

Not Actual Size

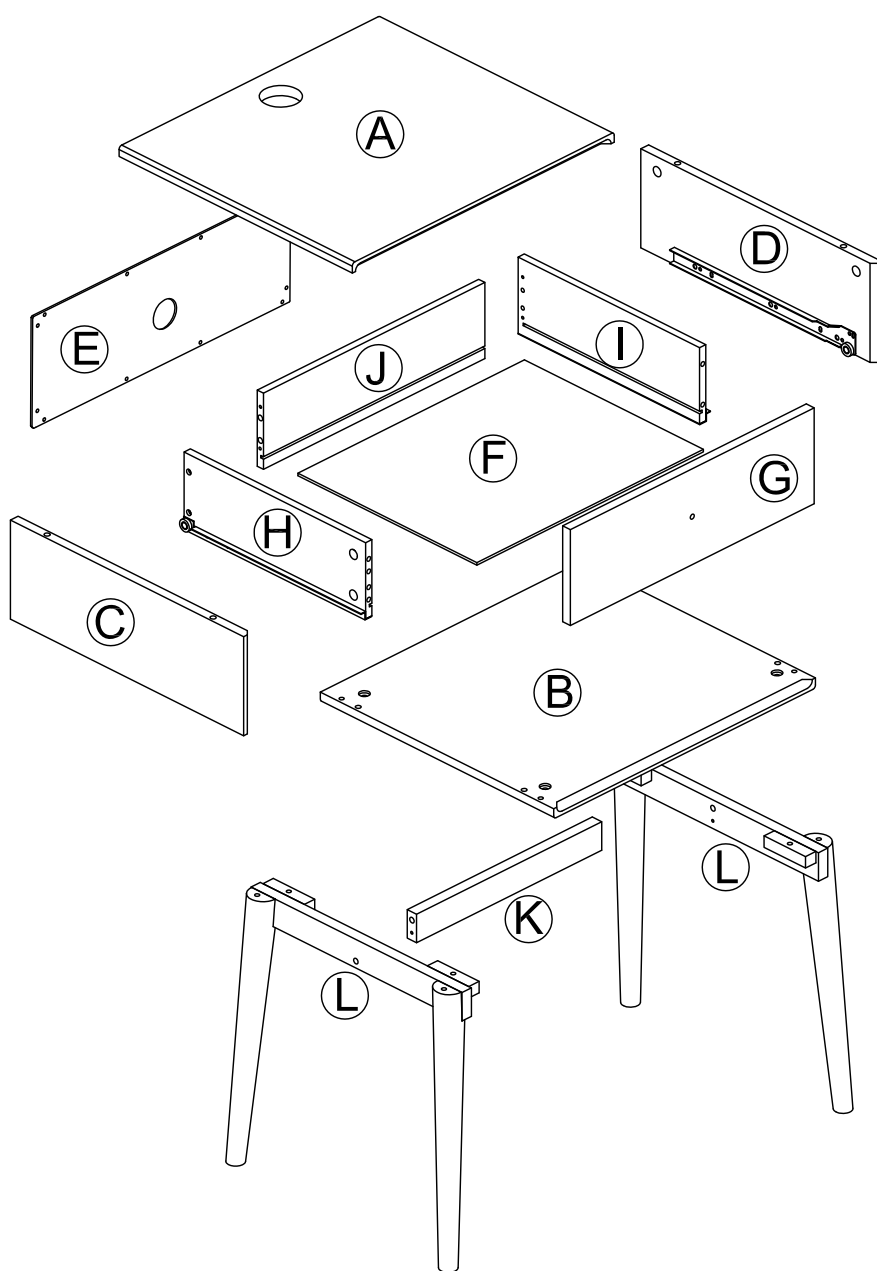

# Part List

## Actual Size

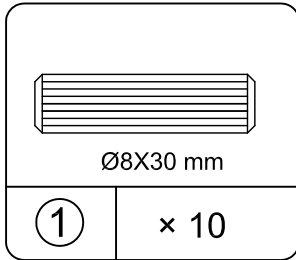

Wood dowel  
TKX1005

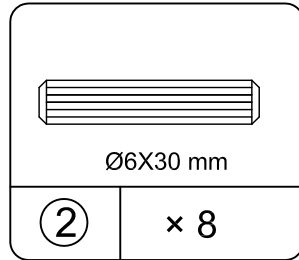

Wood dowel  
TKX1006

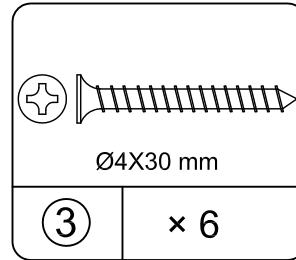

Screw  
TKX1104

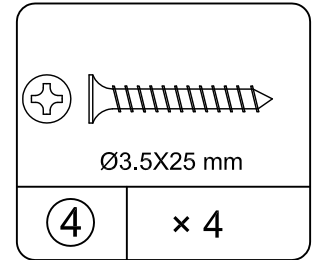

Screw  
TKX1145

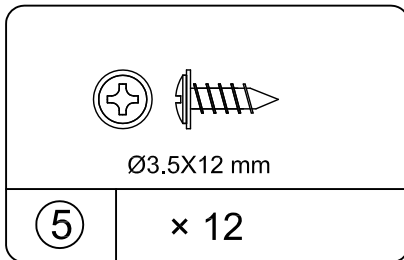

Screw  
TKX1141

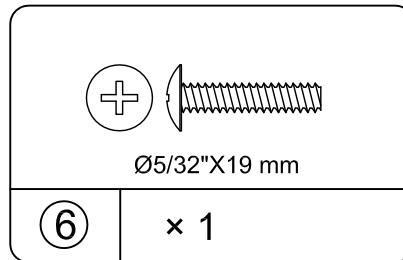

Screw bolt  
TKX1049

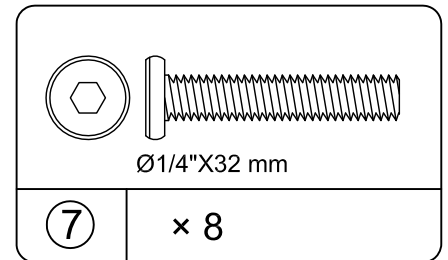

Bolt  
TKX1009

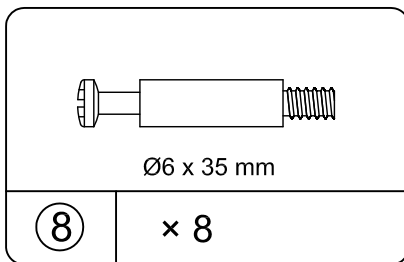

Cam bolt  
TKX1012

Not Actual Size



Hardware Bag Reference Number:  
27847801COM0KX

# Part List

Not Actual Size

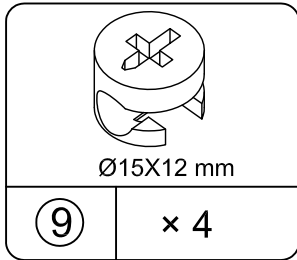

Cam lock  
TKX1022

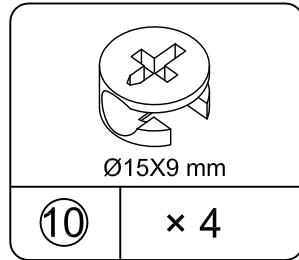

Cam lock  
TKX1023

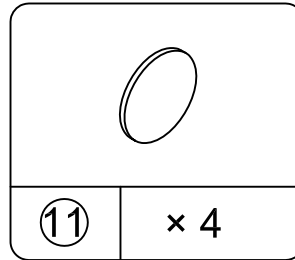

Cam cover  
TKX1013

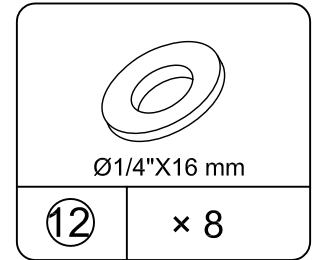

Washer  
TKX1003

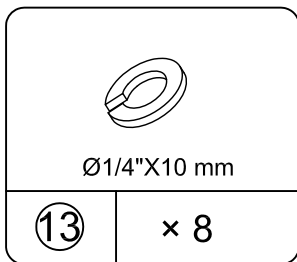

Spring washer  
TKX1002

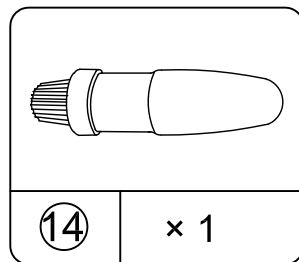

Glue  
TKX1014

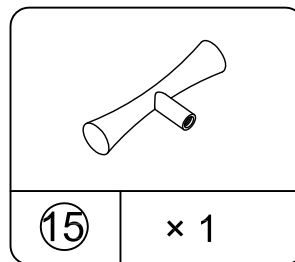

Handle  
TKX1144

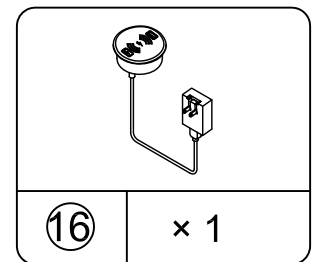

Wireless charging  
TKX1122

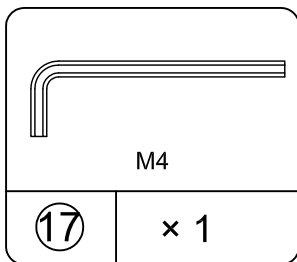

Hex key  
TKX1004





## STEP 1

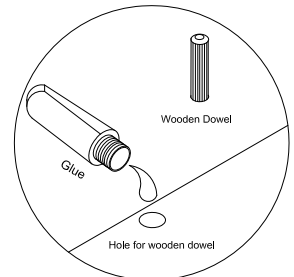
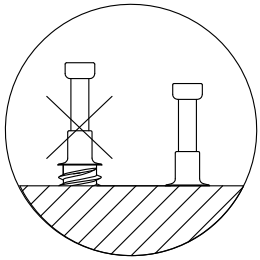
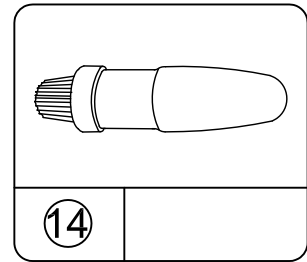
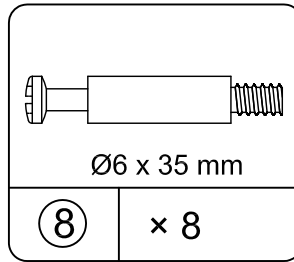
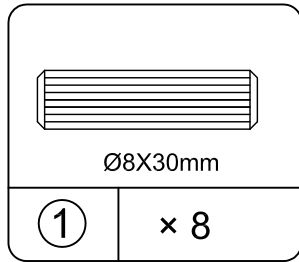
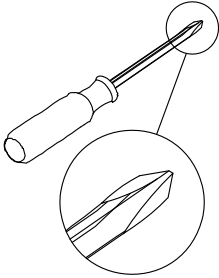

Use one drop of glue in dowel hole.

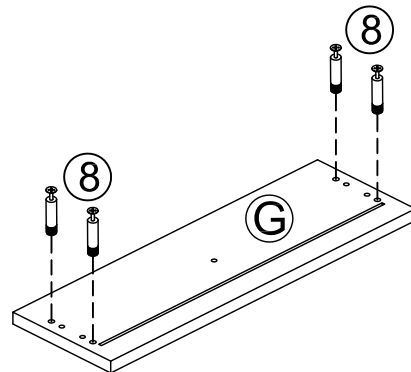
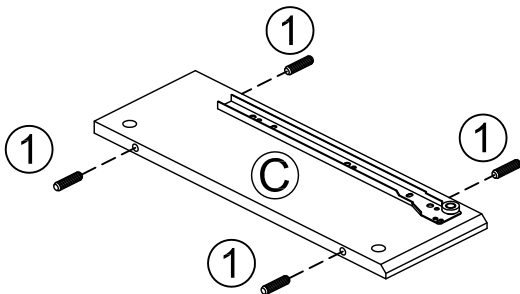
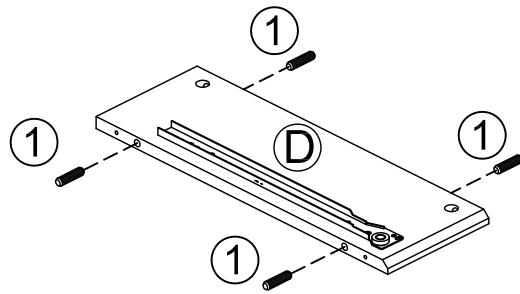
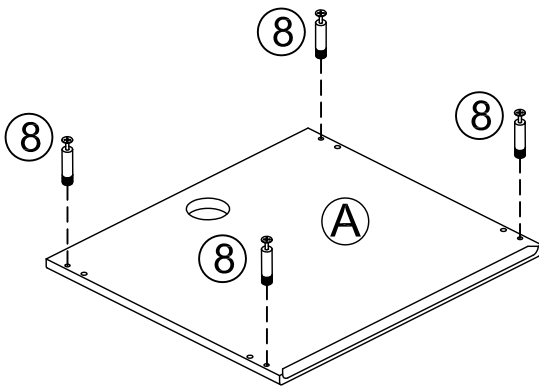

**STEP 2**

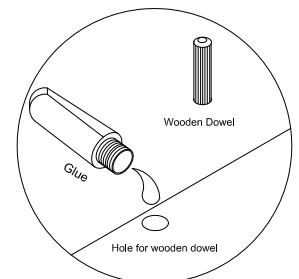
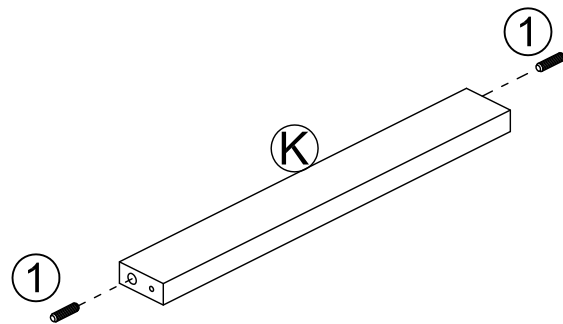
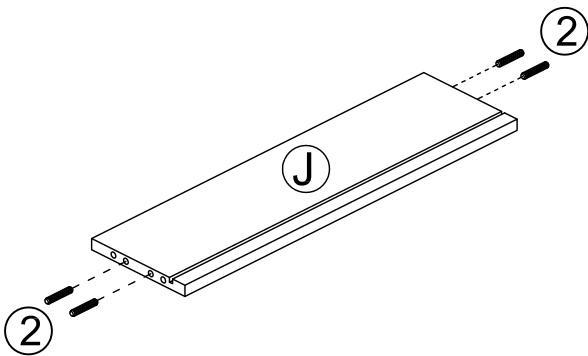
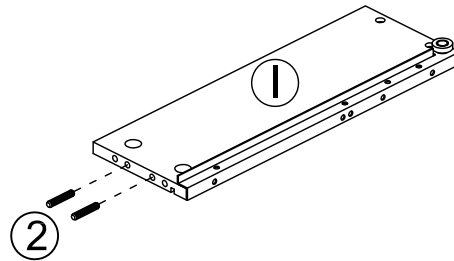
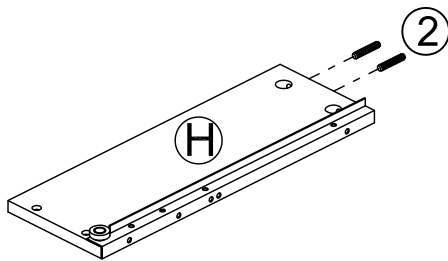
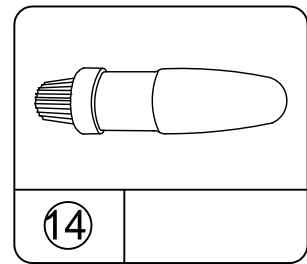
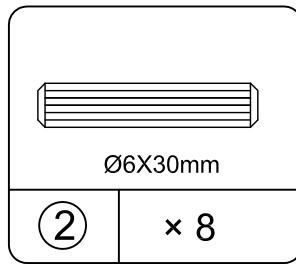
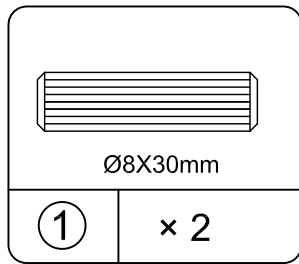
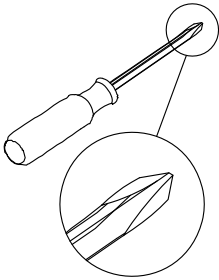

Use one drop of glue in dowel hole.

**STEP 3**

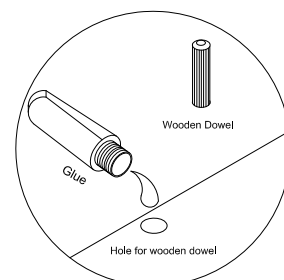
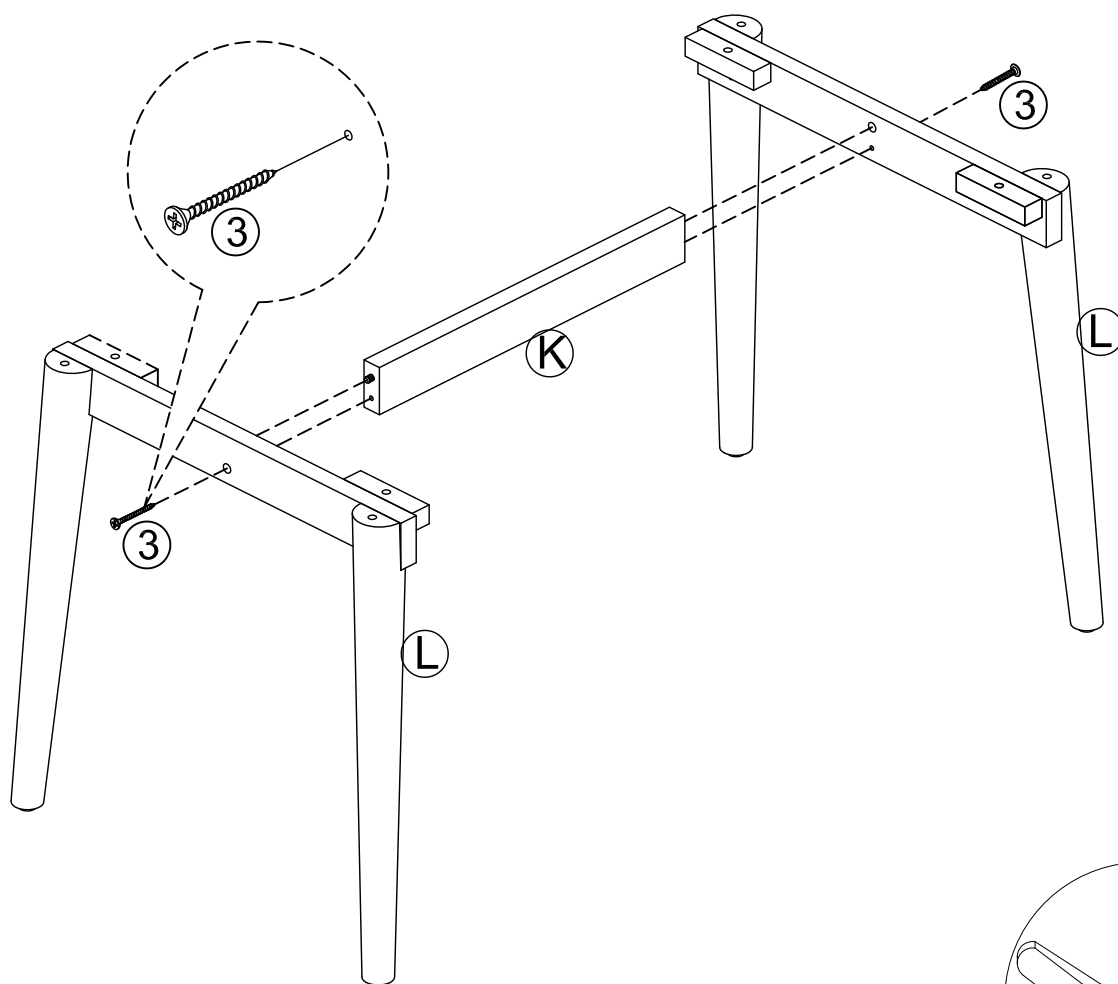
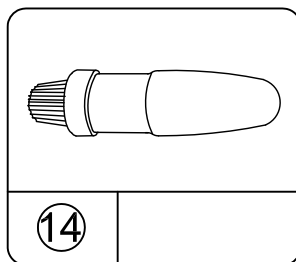
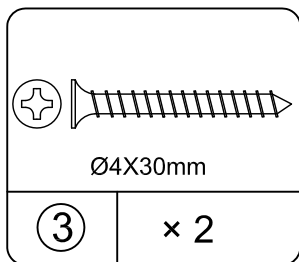
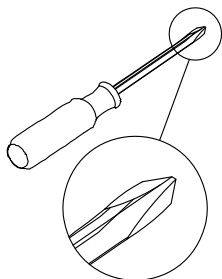

Use one drop of glue in dowel hole.

# STEP 4

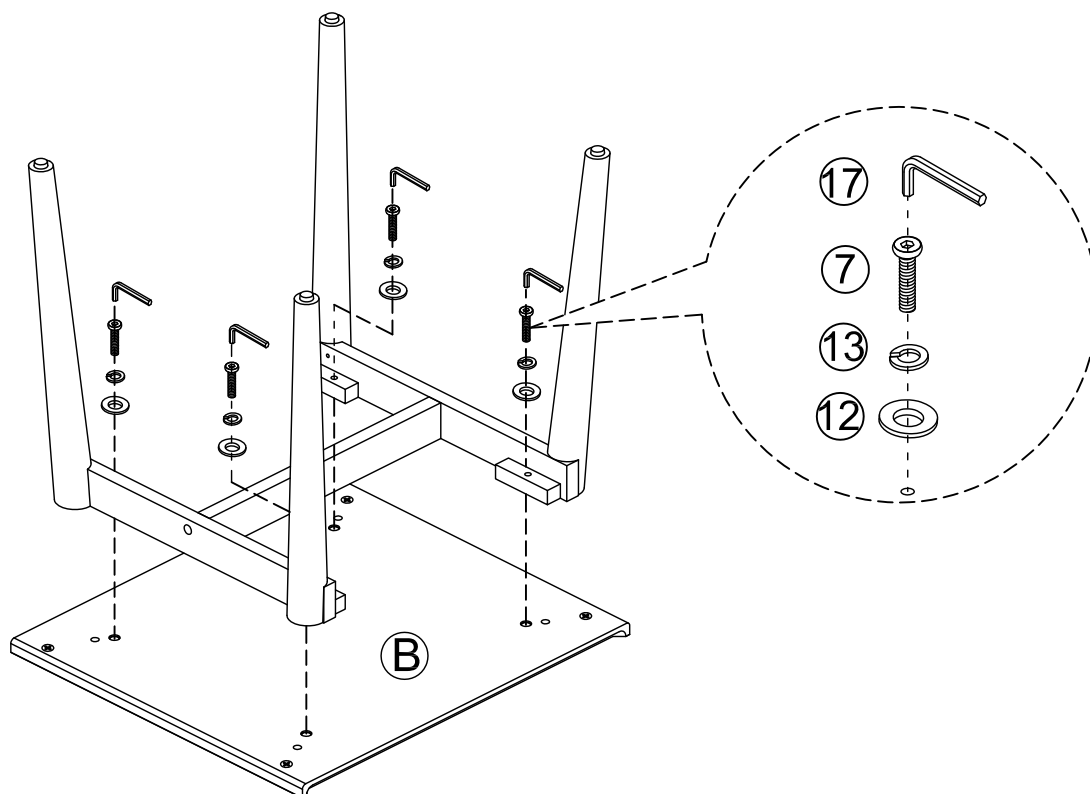
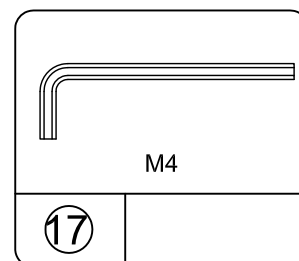
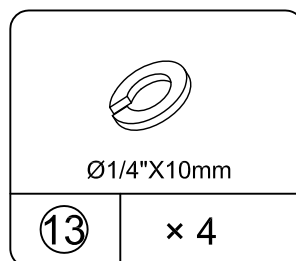
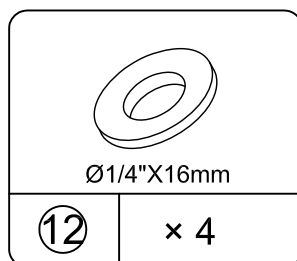
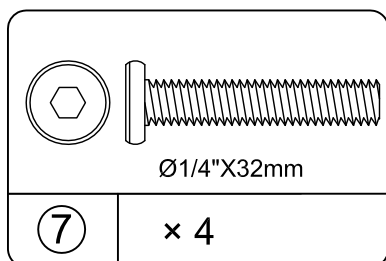

Note: DO NOT Tighten the bolt to ensure the assembly successfully in this step.

**STEP 5**

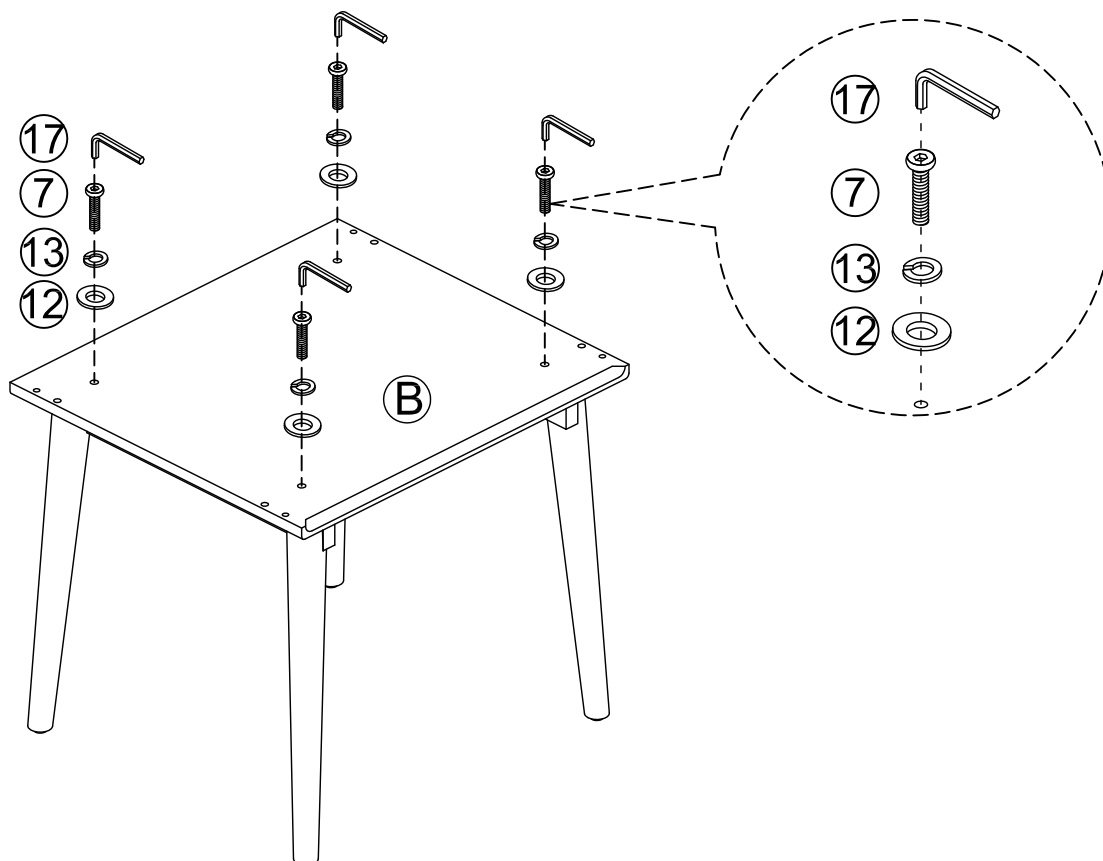
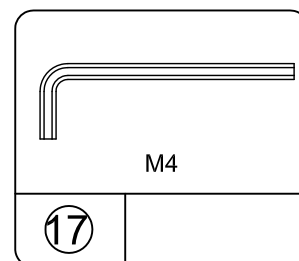
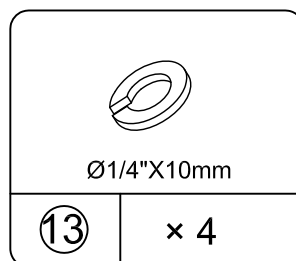
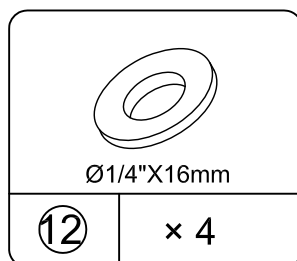
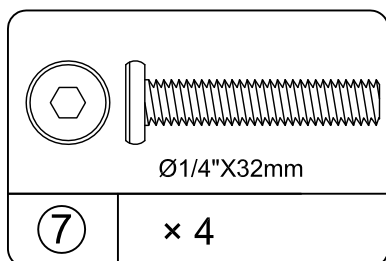

Note: Tighten all bolts to secure the unit in this assembly step.

## STEP 6

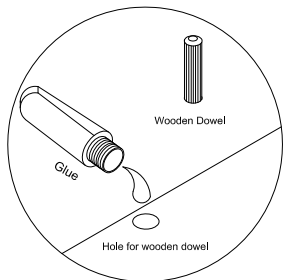
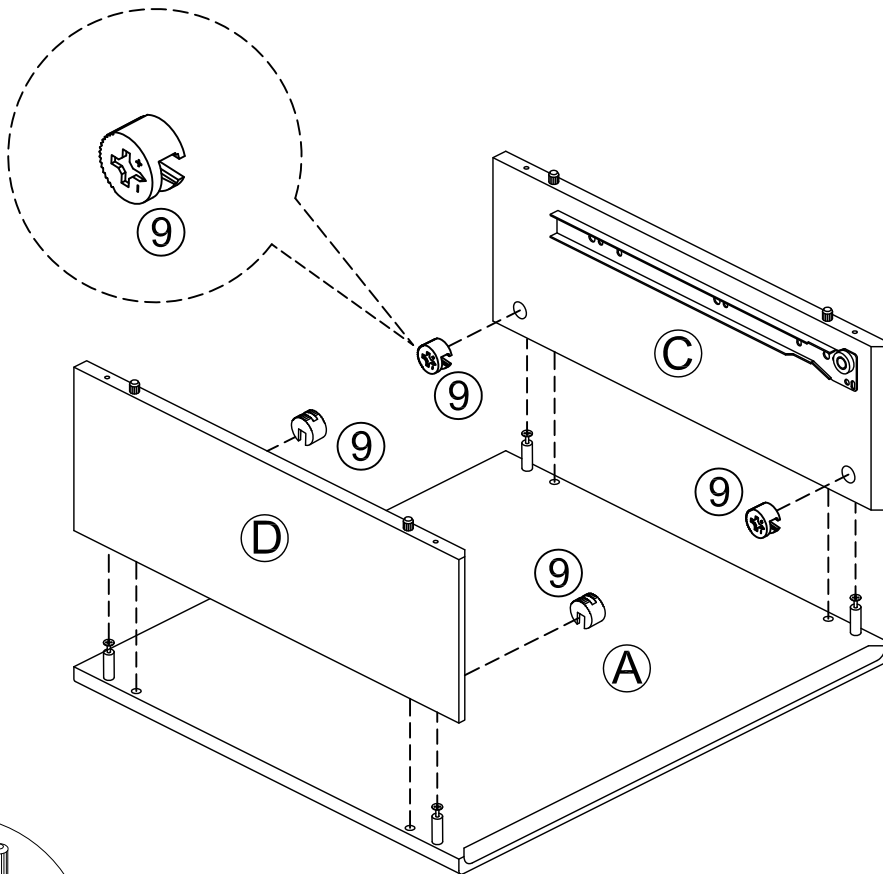
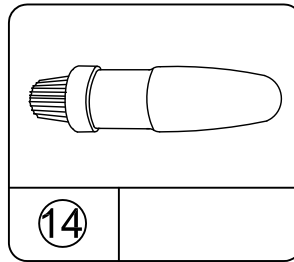
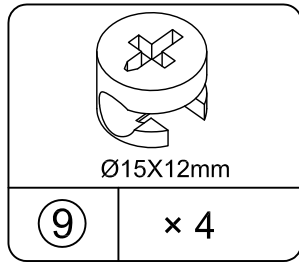
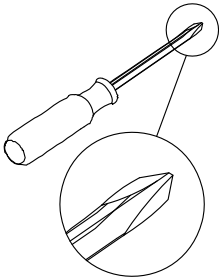

Use one drop of glue in dowel hole.

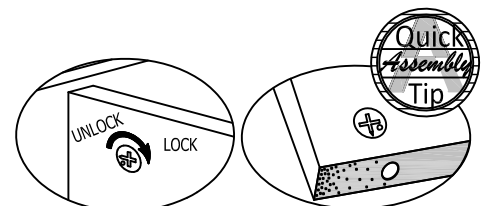

Proper orientation of CAM LOCK

**STEP 7**

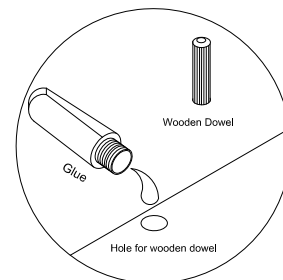
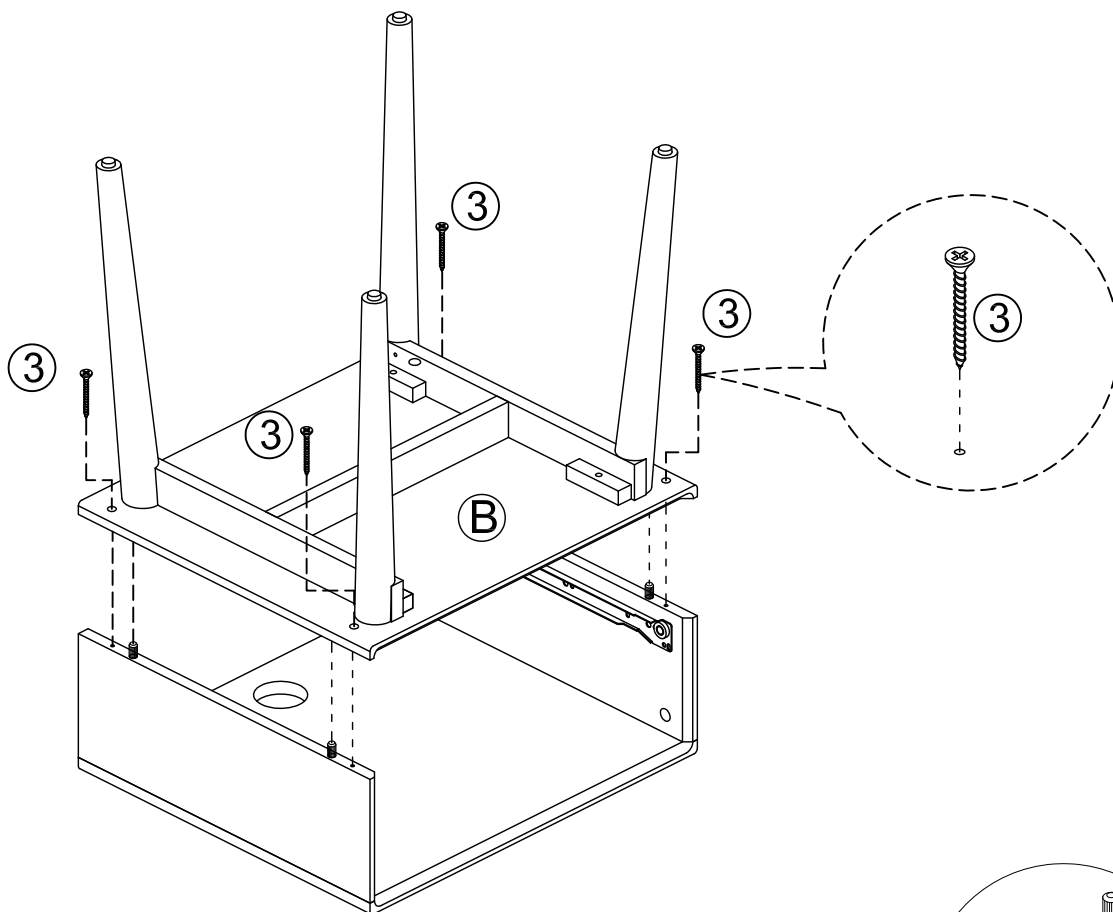
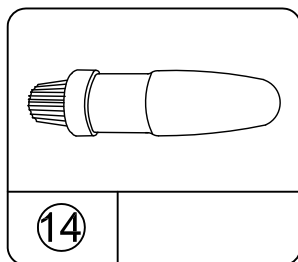
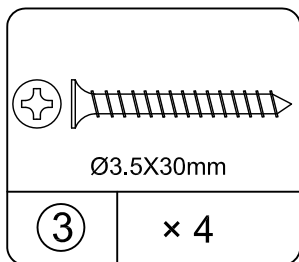
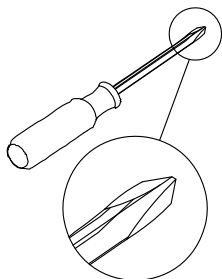

Use one drop of glue in dowel hole.

## STEP 8

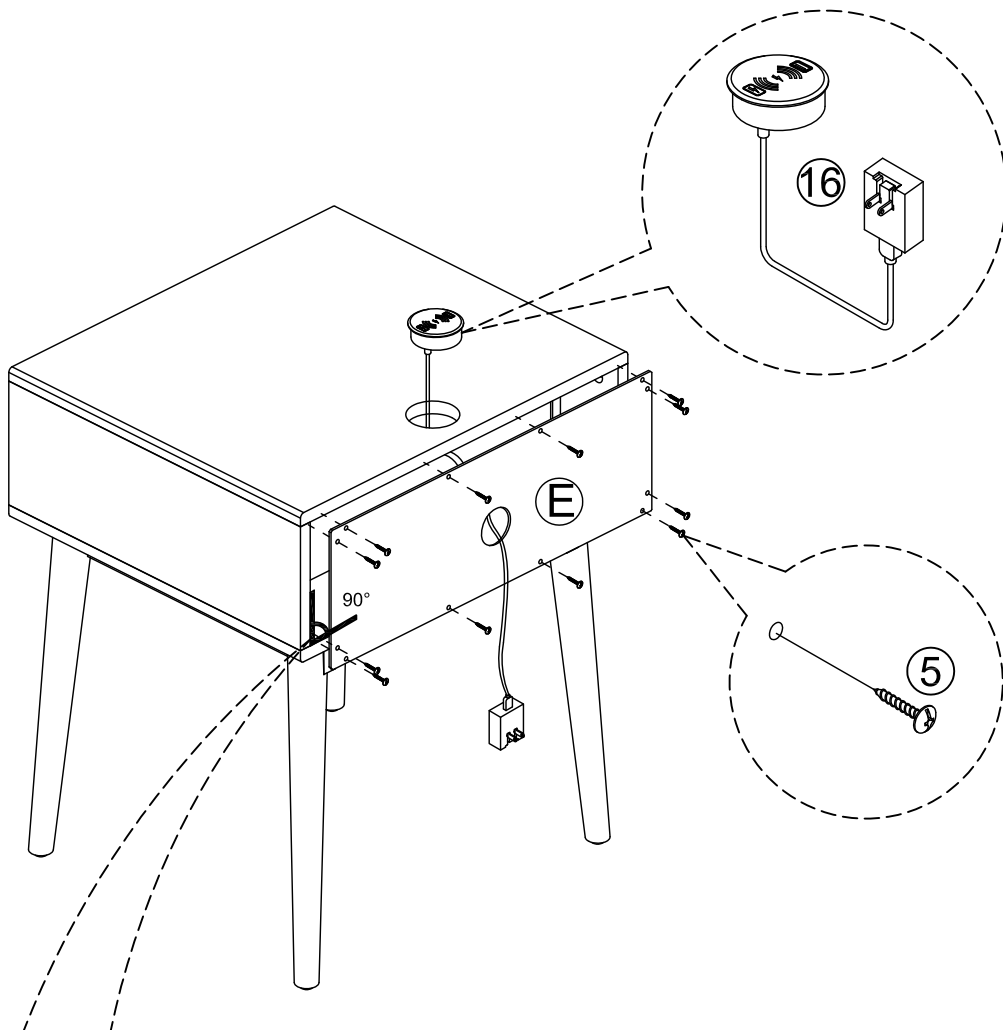
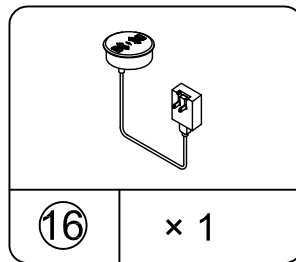
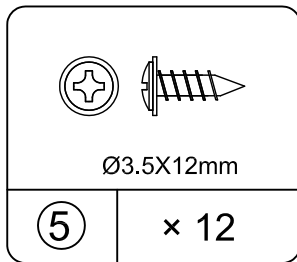
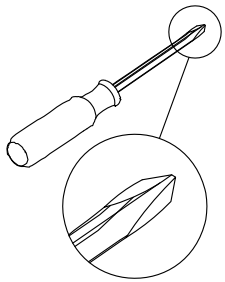

Before attaching the back panel be sure that the unit is at 90°.

### ⚠ WARNING

Please make sure that the backs are attached securely. All screws must be driven into the parts straight and tightened firmly. Failure to do so could cause instability, product collapse, and/or serious injury.



## STEP 9

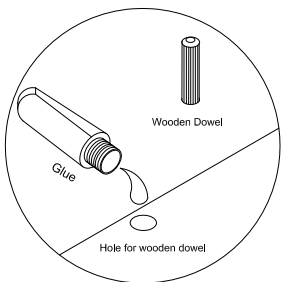
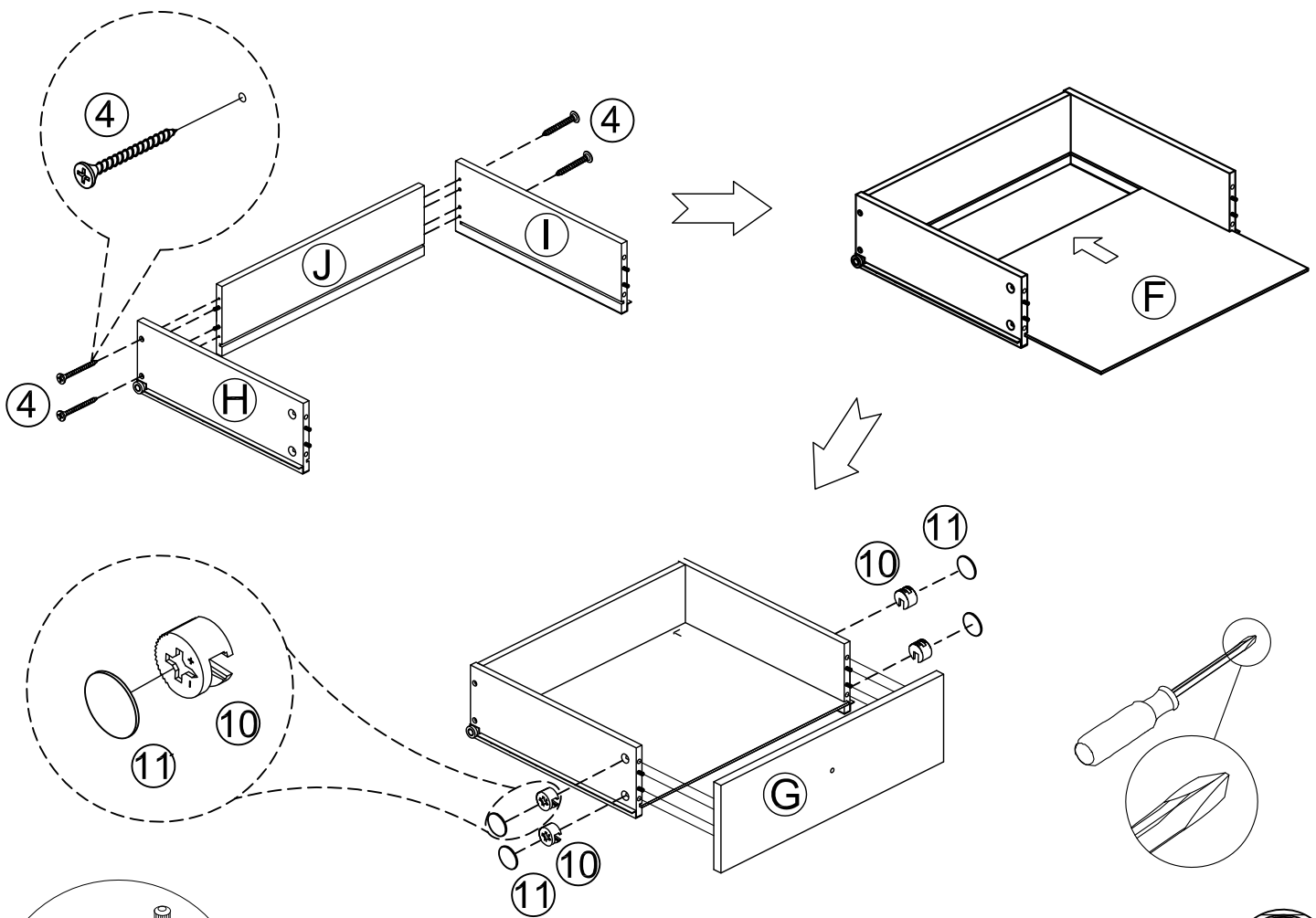
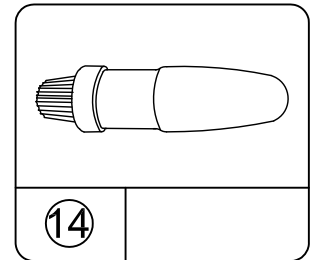
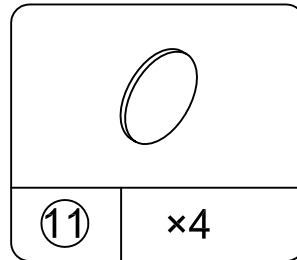
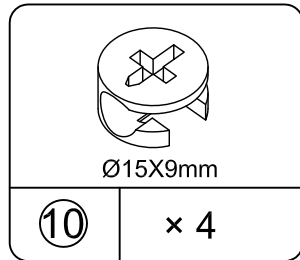
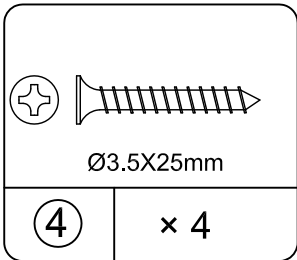

Use one drop of glue in dowel hole.

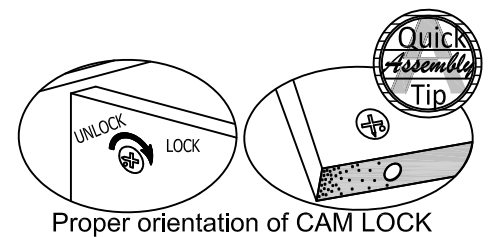

**STEP 10**

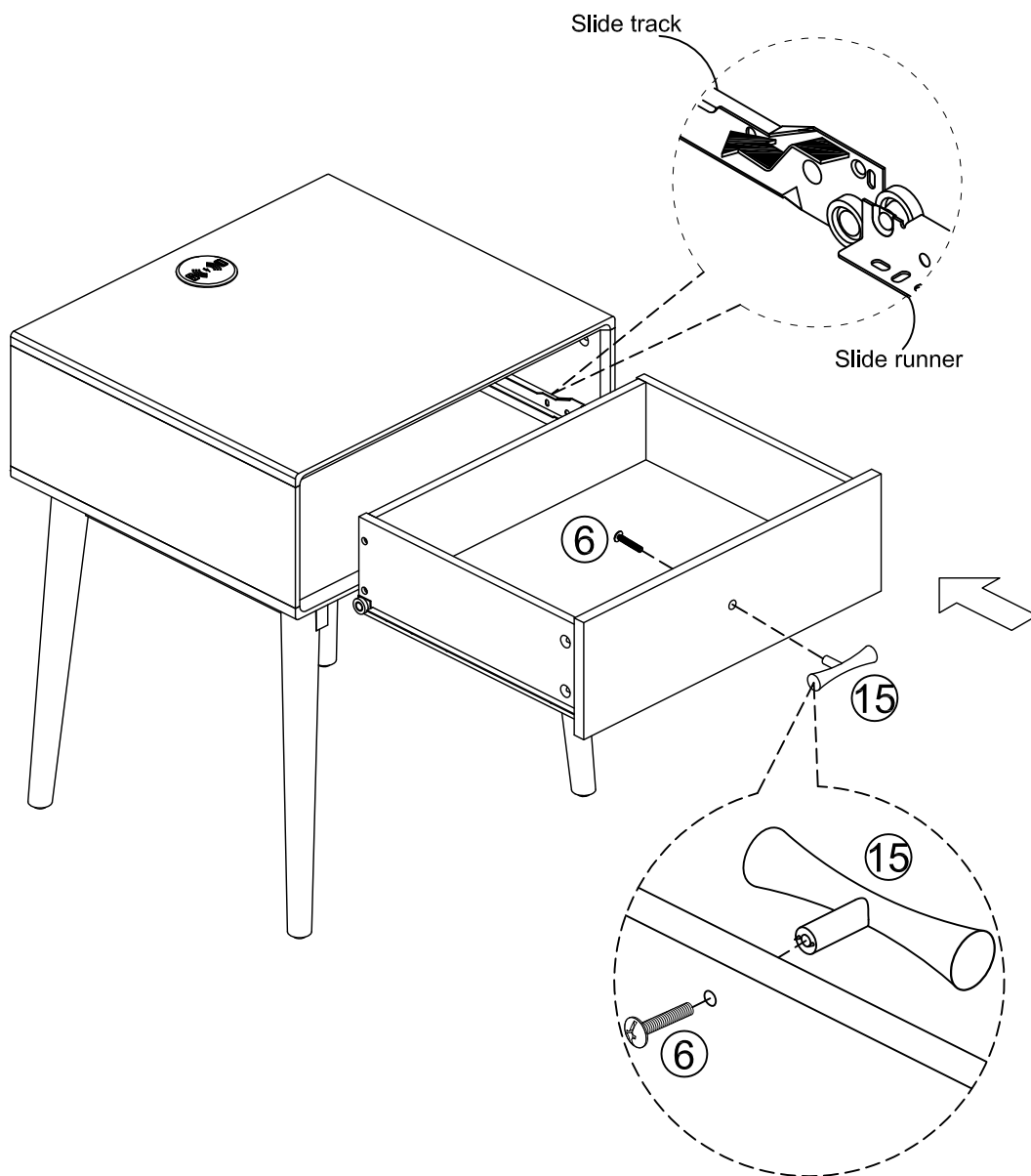
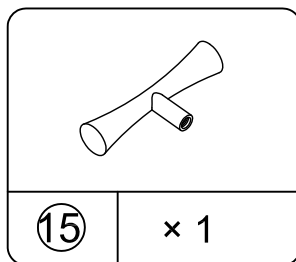
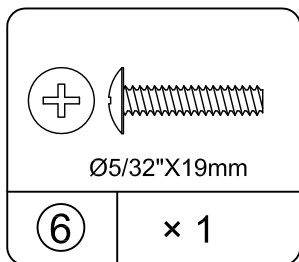
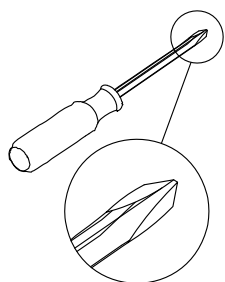

# Maximum Loads

This unit has been designed to support the maximum loads shown. Exceeding these load limits could cause sagging, instability, product collapse, and/or serious injury.

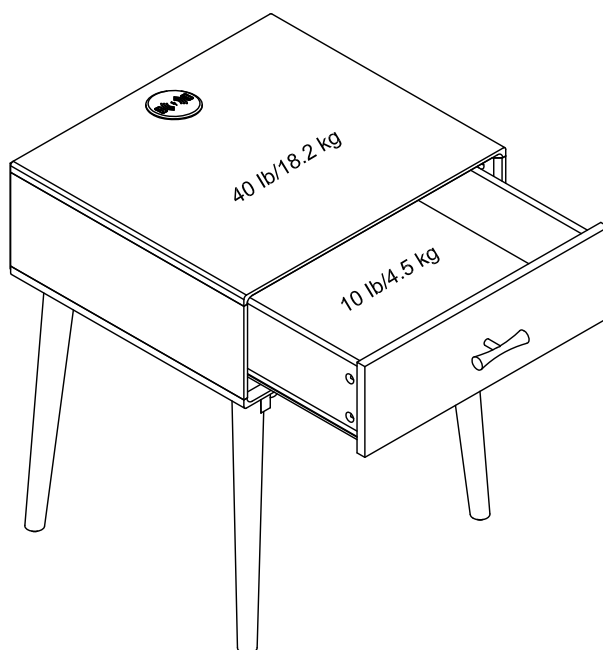

**Warning: Risk of injury to persons - do not place a television on this furniture. This furniture is not approved for use with a television.**

### Certificate of Conformity

1. This certificate applies to the Dorel Home Furnishings, Inc. product identified by this instruction manual.
2. This certificate applies to compliance of this product with the CPSC Ban on Lead-Containing Paint (16 CFR 1303).
3. This product is distributed by: Dorel Home Furnishings, Inc.  
410 East First Street South  
Wright City, MO 63390  
636-745-3351
4. Site of Manufacture: Svay Rieng, Cambodia
5. See front page of instruction manual for date of manufacture.

---

## Register your product to receive the following:



- \* New trend details - sneak peek on what's new
- \* Surveys - have a voice within our community
- \* Exclusive deals and discount codes
- \* Quick and easy replacement part service

To register your product, visit [ameriwoodhome.com](http://ameriwoodhome.com)

## *Star Rating*



Visit your local retailer's website, rate your purchased product and leave us some feedback!

We would like to extend a big "Thank You" to all of our customers for taking the time to assemble this Ameriwood Home product, and to give us your valuable feedback.

*Thank  
You!*

# Español

## Cubierta Delantera

Este libro de instrucciones contiene información **IMPORTANTE** de seguridad. Por favor lea y manténgalo para referencia en el futuro.

**No Regrese este producto!** Comuníquese con nuestro amistoso equipo de servicio al cliente para obtener ayuda.

Llámenos al: 1-800-489-3351 (Gratis) Lunes - Viernes 9am - 5pm CST

Visitar: [www.ameriwoodhome.com](http://www.ameriwoodhome.com)

## PRECAUCION

Este mueble puede volcarse y causar graves heridas y/o muerte.

Anclar el mueble a un poste de madera en la pared (si esto se requiere).

No Permita que los niños monten el mueble.

Mantenga los artículos más pesados en los cajones de abajo.

## Consejos Útiles (página 2)

- Abra su artículo en el área donde usted planea utilizarlo para evitar levantar y moverlo menos
- Identificar, ordenar y contar las piezas antes de intentar ensamblar
- Las clavijas de compresión se golpean con un martillo
- Las diapositivas están marcadas con una R (derecha) y L (izquierda) para la colocación correcta
- Asegúrese de que siempre este el punto localizado en la parte superior de bloqueador de leva este volteado hacia borde exterior
- Utilizar todos los clavos para el panel de atrás y distribuirlos por igual
- El panel de atrás debe utilizarse para asegurarse de que la unidad quede fija y firme
- No use químicas fuertes ni limpiadores abrasivos en este artículo
- Nunca empuje, tire ni arrastre los muebles

## Antes de Que Empieces (página 3)

- Lea cuidadosamente cada paso y siga el orden correcto

- Separar y contar todas sus piezas y hardware

- Dése suficiente espacio para el proceso de ensamble

- Tenga las siguientes herramientas: destornillador de cabeza plana, #2 cabeza Phillips

Destornillador y martillo

- Precaución: Si usa un taladro electrónico o un destornillador eléctrico para atornillar, por favor asegúrese que deje de atornillar cuando el tornillo este apretado. Fallar hacer esto puede causar barrer el tornillo.

## Sistema de fijar el bloqueo de leva (página 3)

Este sistema de fijar el bloqueo de leva será usado en todo el proceso ensamble.

# Español

## Identificación de los Paneles (Página 4-5)

Este no es el tamaño real

- (A) Panel superior
- (B) Panel base
- (C) Panel izquierdo
- (D) Panel lateral derecho
- (E) Panel trasero
- (F) Fondo del cajón
- (G) Frente del cajón
- (H) Lado izquierdo del cajón
- (I) Lado derecho del cajón
- (J) Panel trasero del cajón
- (K) Soporte inferior
- (L) Marco de pata

## Lista de Piezas (Página 7)

Tamaño real

- (1) Clavija de madera
- (2) Clavija de madera
- (3) Tornillo
- (4) Tornillo
- (5) Tornillo
- (6) Tornillo
- (7) Tornillo
- (8) Tornillo de rosca

## Lista de Piezas (Página 8)

Este no es el tamaño real

- (9) Tornillo de cerradura
- (10) Tornillo de cerradura
- (11) Tapa de la leva
- (12) Arandela
- (13) Arandela de resorte
- (14) Pegamento
- (15) Manija
- (16) Carga inalámbrica
- (17) Llave en L

Página 9,10,11

Agujero para clavija de madera. Use una gota de pegamento en el agujero de clavija.

Página 12

Nota: **NO APRIETE** el perno para asegurar un ensamblaje exitoso en este paso.

Página 13

Nota: Apriete todos los pernos para estabilizar la unidad en este paso.

Página 14,15

Agujero para clavija de madera. Use una gota de pegamento en el agujero de clavija.

Página 16

### ADVERTENCIA

Asegúrese de que los paneles traseros están bien sujetos. Todos los tornillos deben ser atornillarse en las partes rectas y estar bien apretados. No hacerlo puede resultar en inestabilidad, derrumbe de mueble y/o lesiones graves.

Antes de atar el panel trasero asegúrese de que se encaja bien con la unidad.

Página 17

Nota: Apriete todos los pernos para estabilizar la unidad en este paso.

# Español

---

Página 19

## CARGA MAXIMA

Esta unidad ha sido diseñada para soportar la carga máxima anotada. El exceder estos límites puede causar inestabilidad, colapsarse y/o causar serias lesiones.

**ADVERTENCIA:** Riesgo de lesiones a las personas - no coloque un televisor sobre muebles. Este mueble no está aprobado para su uso con un televisor.

Página 20

Registre su producto para recibir lo siguiente:

- \* Detalles de nuevas tendencias - Vistazo a lo nuevo
- \* Encuestas - alec su voz entre su comunidad
- \* Códigos de ofertas y descuentos exclusivos
- \* Fácil y rápido servicio de partes de remplace

Para registrar su producto, visite [ameriwoodhome.com](http://ameriwoodhome.com)

Clasificación de 5 estrellas

Visite el sitio web de su tienda local, califique su comprado y denos sus comentarios!

Nos gustaría enviar un gran "Agradecimiento" a todos nuestros clientes por tomarse el tiempo de ensamblar este producto de Ameriwood Home, y por darnos sus valiosos comentarios.

Gracias

# Français

---

## Couverture Avant

CE LIVRET D'INSTRUCTION CONTIENT DES INFORMATIONS **IMPORTANTES** SUR LA SÉCURITÉ. VEUILLEZ LIRE ET GARDER POUR UNE RÉFÉRENCE FUTURE

**Ne retournez pas ce produit!** Contactez notre équipe de service à la clientèle amicale d'abord pour obtenir de l'aide.

**Appelez-nous:** 1-800-489-3351 (sans frais) du Lundi au Vendredi de 9h à 17h Heure Centrale

**Visitez:** [www.ameriwoodhome.com](http://www.ameriwoodhome.com)

## ATTENTION

Le meuble peut basculer et causer des blessures graves ou la mort.

Ancrer le meuble à une planche murale dans le mur (si indiqué).

Ne laissez pas les enfants grimper sur le meuble.

Placez les articles lourds sur les étagères ou dans les tiroirs inférieurs.

## Astuces Utiles (page 2)

-Ouvrez votre article dans la zone que vous prévoyez de le garder pour moins de levage lourd

-Identifier, trier et compter les pièces avant d'essayer d'assembler

-Les goujons de compression sont taraudés avec un Marteau

-Les glissières sont marquées d'un R (droit) et d'un L (gauche) pour un bon placement

-Assurez-vous toujours de faire face la pointe situé sur le haut de la Serrure de Came vers le bord extérieur

-Utiliser tous les clous fournis pour le panneau arrière et les répartir également

-Le panneau arrière doit être utilisé pour vous assurer que votre appareil est robuste

-N'utilisez pas de produits chimiques agressifs ou de nettoyeurs abrasifs sur cet appareil

-Ne jamais pousser, tirer, ou faire glisser votre meuble

## Avant de Commencer (page 3)

-Lisez attentivement chaque étape et suivez le bon ordre

-Séparez et comptez toutes vos pièces et matériaux

-Donnez-vous suffisamment de place pour l'assemblage

-Avoir les outils suivants: tournevis à tête plate, #2 tournevis Phillips, et Marteau

-Attention: Si vous utilisez une perceuse électrique ou un tournevis électrique pour visser, veillez à ralentir et arrêter lorsque la vis est bien serrée. Le non-respect de cette consigne peut endommager la vis.

## Système de Fixation de Came (page 3)

Ce Système de Fixation de Came sera utilisé tout au long de l'assemblage



# Français

---

## Identification des matériaux (Page 4~5)

Pas de taille réelle

- (A) Panneau supérieur
- (B) Panneau inférieur
- (C) Panneau gauche
- (D) Panneau droit
- (E) Panneau arrière
- (F) Fond de tiroir
- (G) Devant de tiroir
- (H) Côté gauche du tiroir
- (I) Côté droit de tiroir
- (J) Dos de tiroir
- (K) Support inférieur
- (L) Cadre de patte

## Liste des pièces (Page 7)

Taille réelle

- (1) Goujon en bois
- (2) Goujon en bois
- (3) Vis
- (4) Vis
- (5) Vis
- (6) Boulon
- (7) Boulon
- (8) Boulon de came

## Liste des pièces (Page 8)

Pas de taille réelle

- (9) Serrure de came
- (10) Serrure de came
- (11) Abri de la came
- (12) Rondelle
- (13) Rondelle à ressort
- (14) Colle
- (15) Poignée
- (16) Chargement sans fil
- (17) Clé hexagonale

## Page 9,10,11

Trou pour cheville en bois. Utilisez une goutte de colle dans le trou de la cheville.

## Page 12

Note: NE PAS serrer le boulon complètement à cette étape pour faciliter l'assemblage.

## Page 13

Note: Serrez tous les boulons à cette étape pour bien fixer l'unité.

## Page 14,15

Trou pour cheville en bois. Utilisez une goutte de colle dans le trou de la cheville.

## Page 16

### AVERTISSEMENT

S'il-vous-plaît assurez-vous que les PANNEAUX ARRIÈRE sont attachés solidement. Tous les clous doivent être enfoncés perpendiculairement et solidement dans les parties. Sinon le meuble peut devenir instable, s'effondrer subitement et/ou causer des blessures graves.

Avant de fixer le panneau arrière, assurez-vous que l'unité est d'équerre à 90°.

## Page 17

Trou pour cheville en bois. Utilisez une goutte de colle dans le trou de la cheville.

# Français

---

Page 19

## CHARGES MAXIMALES

Ce meuble a été conçu pour supporter les charges maximales indiquées. En excédant ces limites de charge, le meuble pourrait devenir instable, s'effondrer, et/ou causer des blessures graves.

AVERTISSEMENT : Risque de blessure corporelle - ne pas placer une télévision sur ce meuble. Ce meuble n'est pas approuvé pour une utilisation avec une télévision.

Page 20

Enregistrez votre produit pour recevoir les éléments suivantes:

- \* Détails sur les nouvelles tendances - un aperçu sur les nouveautés
- \* Sondages - avoir une voix au sein de notre communauté
- \* Offres exclusives et codes promo
- \* Service de pièces de rechange rapide et facile

Pour enregistrer votre produit, visitez [ameriwoodhome.com](http://ameriwoodhome.com)

5 Étoiles

Visitez le site Web de votre détaillant local, évaluez votre produit acheté et laissez-nous quelques commentaires !

Nous tenons à offrir un grand "Merci" à tous nos clients pour avoir pris le temps d'assembler ce produit "Ameriwood Home", et de nous donner vos commentaires précieux.

Merci